

KeyConductor

The most **efficient** and **secure**
solution for **managing keys**



ELECTRONIC KEY CONTROL | Automated issuing and return

Sleutelbeheer is voor veel organisaties een uitdaging. Niets is namelijk vervelender om belangrijke sleutels te verliezen.

Key control is a challenge for many companies. There is nothing worse than the loss of important keys. Apart from the security risks, key loss is often accompanied by high costs for lock replacement and it also interrupts business processes.



“Cost efficient and secure solution for managing keys”

Electronic key cabinet

The KeyConductor makes the process of issuing and returning keys automatic. You decide who can use which key to gain access to certain assets or areas in the Connect Software. The system saves these details and lets you see who has which key, when it was issued and when it was returned. An alert can be sent to the administrator if a key is not returned on time.

Just some of the benefits:



Time and cost efficient

Minimise administrative tasks and never waste time looking for keys again



Security

Maintain control over critical keys and avoid the serious consequences of loss



Registration

All the keys in your organisation are recorded and monitored



100% oversight

Complete oversight of the real-time situation, alerts and reports



Integration with the existing IT environment

Connects to diverse applications and all current access control systems



Increase your level of service

Make issuing and returning keys possible 24/7

KEYCOP | Secure key fob

Your keys are put on a KeyCop so that they can be managed electronically with the KeyConductor. The KeyCop is a fob which is securely attached to one or more keys. The KeyCop's unique number is also engraved onto it by laser as a barcode and number.

To collect keys, employees log on in the KeyConductor by means of a tag, pass, code or fingerprint. The key for which they are authorised lights up and is unlocked.

Various forms

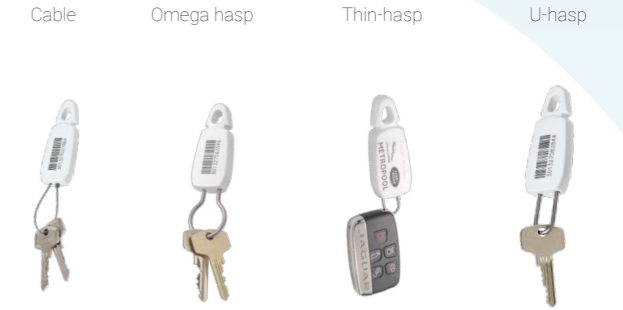

KEYCONDUCTOR | From 12 to 6,000 sets of keys

Nauta Connect has a series of standard solutions for the electronic control of 12 to 6,000 keys or sets of keys. The KeyConductor works with preferred key positions (barcode).

The KeyConductor is filled per track. A track is made up of 12 key places.

Features

- Robust steel cabinet
- Possible to add UPS
- Plexiglass windows or blind door
- Pass reader possible



HOW IT WORKS | Pick-to-light and barcode

To collect KeyCops, employees log on in the KeyConductor by means of a code, a pass or a tag. Once the authorised key is selected, it is unlocked and the key position is lit up.

Pick-to-Light offers a simple and fail-safe way of working. Clear colour coding indicates which KeyCop should be taken and in which position it should be replaced.

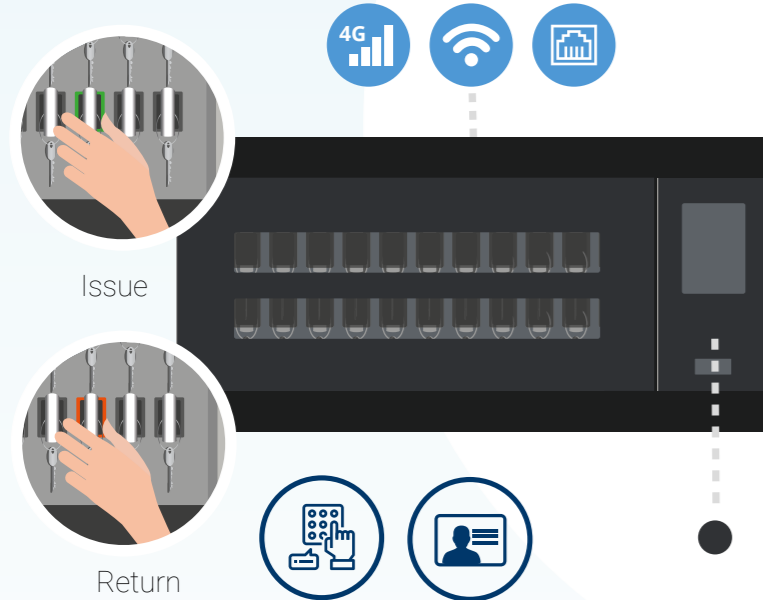
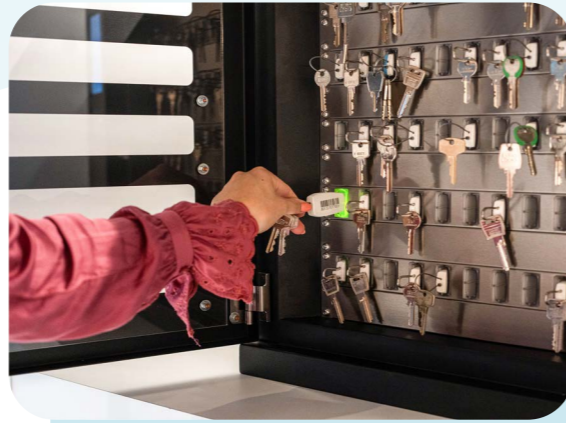

- **Scalable up to thousands of key positions**
- **Easily expanded with extra tracks**
- **Simple installation**
- **Free trial possible**
- **Lease option**

COMBILOCKER | Combination with operational asset control

You can combine the secure storage of operational assets with electronic key control. The KeyConductor solution is then integrated with a CapLocker.

As a Nauta Connect Software user, you can also control your operational assets quickly and efficiently. With our smart locker system, you know precisely who has taken what, when and if it has been returned on time. The CapLocker can be used for valuable assets, like laptops, scanners and tablets.

Nauta Connect also offers the option of an application to book operational assets. Users make a reservation via a web application and collect the assets or keys with a QR-code.



SOFTWARE | Complete web application

User-friendly software is indispensable to ensure that a system works well. The Nauta Connect Software has been specifically developed to control keys and present a complete audit trail.

Benefits

- Simple control of users and keys
- Watertight, up-to-date user data
- Central control of several KeyConductors
- Web-based application
- Complete oversight of key use and access to reports





Nauta Connect Software can be hosted in a Microsoft Azure Cloud environment, so you don't have to set-up your own server and you only need a web browser and internet connection.

Benefits

- You don't need your own server or server management
- 99.99% availability
- Simple service and support available

INTEGRATION WITH EXISTING SOFTWARE | All your data systems connected to each other

Does your organisation already use facility management software or an access control system? We ensure a flawless connection with the Connect software. This allows you to continue working in your familiar environment without the need to manually enter data.

We have extensive experience in integrating all common systems such as TOPdesk, SALTO, SURFconext and Active Directory. Is your solution not listed? Please do not hesitate to contact us.

Existing access pass

The Connect software is suitable for any organisation size. We offer various options to integrate your data such as users, access passes, status and rights. Our specialists are happy to advise you on the optimal integration for your situation.



INSTALLATION, SERVICE AND SUPPORT | Our developers think with you

Nauta Connect, a supplier of a total solution, offers the guarantee of flawless performance. The Nauta Connect Software has been designed by our own software development team and is hosted in the Netherlands. They have an abundance of practical expertise and are happy to talk to you about improving the control of your operational assets.

Implementation

To ensure a smooth implementation and optimal user experience, we offer an onboarding programme that completely takes care of everything for you.

- Onboarding programme
- Cloud environment installation
- KeyConductor installation
- Software training for administrators
- Three months of free support



Installation including training for administrators

On location or online

Advice on configuring the system

We help you map out your organisation

Our own support team

Our development team means that we can respond quickly, even remotely

Service and Support

Even after the solution has been installed by us, you can continue to rely on our support. Nauta Connect has its own service and support organisation in Europe and the USA.

We help your company streamline processes, provide employees with an overview, and simplify the workflow. Would you like to discuss the possibilities first?

Please feel free to contact us or request a demo directly.

ASK FOR A NO-OBLIGATION DEMO VIA OUR [WEBSITE](#)

Online or on our premises

MODELS | Easily expanded with extra tracks

24 KeyCop positions

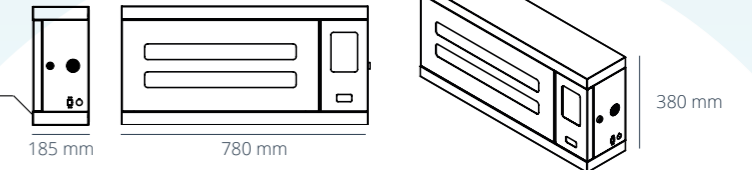

60 KeyCop positions

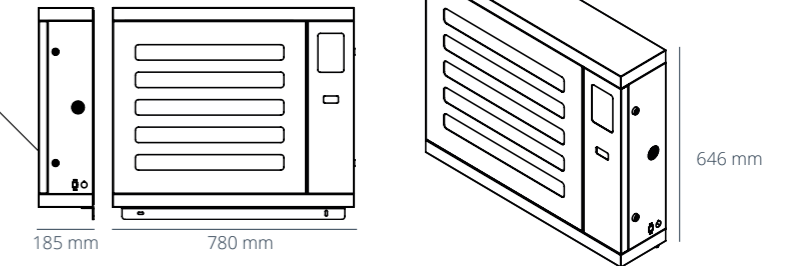

108 KeyCop positions

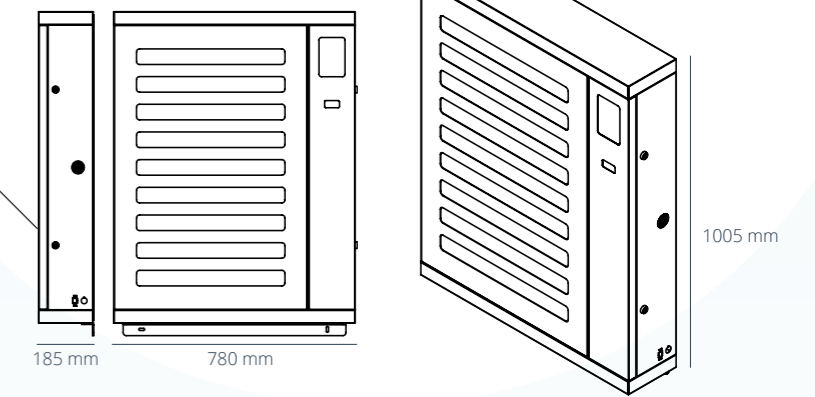

180 KeyCop positions

